



RETAIL

R140

R120

R100

R80

R8

index

1. SAFETY MEASURES	5
2. DESCRIPTION	7
3. INSTRUCTIONS	8
4. IDENTIFICATION	8
5. TECHNICAL CHARACTERISTICS	9
6. INSTALLATION	11
7. REGULATION	12
8. OPERATION	15
9. CONFIGURATION	17
10. CLEANING	18
11. MAINTENANCE	20
12. EC CONFORMITY	23

1. SECURITY

NOTE: The manufacturer will not be held responsible for any damages resulting from improper use of the equipment, or for not following the safety measures as outlined below.

Safety measures incorporated into our grinders:

- Special screw to maintain the hopper fixed in place.
- Access restrictor in the grind group.

Owners: Please pay careful attention with the following instructions:

- The grinder should be used exclusively for the function for which it was designed: grinding whole bean coffee.
- Do not use this grinder to grind other types of food products such as dry fruit, sugar or spices.
- This appliance can be used by children aged from 8 years and above and persons with reduced physical, sensory or mental capabilities or lack of experience and knowledge if they have been given supervision or instruction concerning use of the appliance in a safe way and understand the hazards involved. Children shall not play with the appliance. Cleaning and user maintenance shall not be made by children without supervision.
- Any other use of the machine will be considered improper and dangerous.

- Do not put liquids in contact with internal or external parts of this grinder while ON or OFF, with the exception of parts expressly outlined in the “CLEANING” section of this manual. If liquids do come in contact with the grinder, immediately disconnect electrical connection and carefully clean the affected areas. If it is necessary to access the interior parts of the grinder, contact your local service professional.
- In case of any damage to parts or components, we recommend contacting your local service professional to help with repair or replacement of such parts, thereby guaranteeing the maintenance of the security standards of the grinder.
- If the supply cord is damaged, it must be replaced by the manufacturer, its service agent or similarly qualified persons in order to avoid a hazard.
- Only an authorized distributor should replace the main power cable of the grinder.

SOUND DECIBEL LEVEL

The level of sound emitted in different models is:

Sound decibel level	With coffee
R8	68,2 dB
R80	70 dB
R100	70,6 dB
R120	78,4 dB
R140	78,7 dB
R120 ψ	79,6 dB
R140 ψ	80,6 dB

2. DESCRIPTION

Your new grinder has been designed using the most sophisticated technologies in existence. The result is a product of high quality that offers the assurance of the best results possible. Our products are manufactured by hand, one by one, following the strictest quality requirements. In the manufacturing process, we use only the highest quality materials (aluminum, stainless steel, etc.) especially designated for being in contact with food stuff.

For the optimum functionality of the grinder models described in this user manual, the maximum work cycles are as follows:

Model	Working cycle	
	ON	OFF
R8, R80, R100	1 minute	2 minutes
R120, R140	2 minutes	1 minute
R120 ψ, R140 ψ	continuous	continuous

3. INSTRUCTIONS



3.1. This manual is designed to provide the necessary information to correctly install, use and maintain the grinder, as well as to highlight precautions for users to keep in mind. To ensure the best operation of the coffee grinder, please follow the instructions as outlined in this manual. This manual should be saved for the life of the grinder, and should always be at the disposal of the operator.

3.2. This manual contains special terminology such as:

- Words in **BOLD** indicate important points or terminology.
- Numbers in parentheses after a word, indicate the location of this item in a parts diagram.

Example: (1) - 1 Hopper lid

- Icons:

Information	Attention
	

4. IDENTIFICATION

In the grinder information plaque is the following manufacturing/product information.



NOTE: The manufacturer reserves the right to change components/configurations of any model, according to the different geographic market demands.

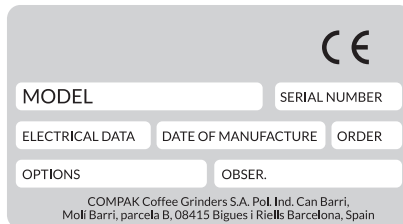

Information plaque containing the following fields and text:

- CE mark
- MODEL
- SERIAL NUMBER
- ELECTRICAL DATA
- DATE OF MANUFACTURE
- ORDER
- OPTIONS
- OBSER.
- COMPACT Coffee Grinders S.A. Pol. Ind. Can Barri,
Molí Barri, parcel·la B, 08·415 Bigues i Riells Barcelona, Spain

5. TECHNICAL CHARACTERISTICS

5.1. Usage

The coffee grinders are intended for use on commercial premises and facilities where ground coffee is required, or in small stores that sell coffee. The grinder must only be used to grind coffee beans. Any use other than this will be considered improper and dangerous.



NOTE: The manufacturer will not be held responsible for any damages resulting from improper use of the equipment, or for not following the safety measures as outlined below.

5.2. Technical data

Model		100 V 50 Hz	100 V 60 Hz	110 V 60 Hz	220 V 60 Hz	230 V 50 Hz	240 V 50 Hz	380 V Ψ 50 Hz	208 V Δ 60 Hz	
R8	Electric power	600	700	700	730	610	630	420		(W)
	Spin speed	1.270	1.530	1.580	1.500	1.290	1.310	920		rpm
R80	Electric power	750	810	420	470	500	600			(W)
	Spin speed	1.250	1.540	1.100	1.100	1.400	1.400			rpm
R100	Electric power	850	1.000	520	650	700	800			(W)
	Spin speed	1.125	1.540	1.100	1.050	1.400	1.400			rpm
R120	Electric power			1.000	1.050	1.000	1.700	1.000	1.000	(W)
	Spin speed			1.130	1.130	1.400	1.400	1.400	1.620	rpm
R140	Electric power					1.700	1.500	1.600	1.600	(W)
	Spin speed					1.400	1.400	1.400	1.620	rpm

	Model										
	R8		R80		R100		R120		R140		
Ø Burrs	3.26		3.14		3.93		4.7		5.5		in
	83		80		100		120		140		mm
Production* 50Hz	1.1		1.1		2.2		3.30		4.4		lb/min
	0,5		0,5		1		1,5		2		Kg/min
Production* 60Hz	1.17		1.17		2.64		4		6.5		lb/min
	0,53		0,53		1,2		1,85		2,95		Kg/min
Hopper capacity	2.2		2.2		2.2		4.85		4.85		lb
	1,1		1,1		1,1		2,2		2,2		Kg
Net weight	46.2		48.57		55.19		81.57		80.08		lb
	21,1		22,08		22,09		37,08		36,4		Kg
Height	23.20	595	23.20	595	23.20	595	30.22	775	30.22	775	
Width	8	205	8	205	8	205	9	230	9	230	
Depth	12.28	315	12.28	315	12.28	315	14.82	380	14.82	380	
	in	mm	in	mm	in	mm	in	mm	in	mm	

* Production is based on a medium-roasted coffee and an Espresso grind.

6. EXTERNAL COMPONENTS



7. INSTALLATION

7.1. General warnings

 The person installing the grinder should carefully read this instruction manual before installation. The installation of this machine should be completed by qualified and authorized personnel, and all norms of safety and sanitation should be followed.

7.2. Important warnings

 The operator of the grinder should be a responsible adult, and a never a minor or person incapable of safely using such equipment. **When using the grinder, the following precautions should be followed:**

- No bare feet.
- No wet hands or feet.
- Do not submerge in water.
- Do not expose the grinder to sun or other atmospheric conditions.
- Do not place any type of object in the coffee entrance or exit while the grinder is running. (It should be kept in mind that the cutting burrs continue turning for a couple revolutions after the grinder is powered off).
- To disconnect the grinder, use the main power switch and never the power cable, to avoid a possible short circuit.

7.3. Where to use



The grinder should be installed on a flat, stable surface. The minimum dimensions of the work space should be as follows:

	Model		
	R8, R80, R100	R120, R140	
Height	28.35	35.43	in
	720	900	mm
Width	9.45	10.43	in
	240	265	mm
Depth	13.78	16.34	in
	350	415	mm

7.4. Grinder installation

Before grinder installation, the following should be considered:

- The grinder information plaque data coincides with the electrical system on site.
- The electrical outlet coincides with the grinder plug.
- The electric power at the location of installation should meet the minimum required to properly run the grinder.
- The installation site should have the proper electrical overload protections.
- The grinder should be properly grounded as specified by local code.



The three-phase models are sold without the plug. In these models, you will be given an uncovered power cable.

Please, check that the three-phase factory installation is correct.

Make sure our socket is EN 60529 and has 3F+N+T and the distribution of the connection should be as in **Figure 2**.

Obtain 380V 50Hz or 220V 60 Hz between phases (F) and 230V 50Hz or 110V 60Hz between Phase and Neutral (F-N).



Fig. 1

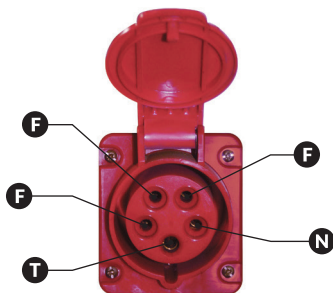

Fig. 2

In order for a correct grind, the burrs have to turn in a counter-clockwise direction. When plugging in a three-phase grinder for the first time, check that the burrs turn in the right direction by opening the cover and looking into the hopper.

If the direction of the burrs is not correct, unplug the grinder and, with the help of a flat-head screwdriver, turn the phase reversal device 180° as soon shown in **Figure 1**. When you plug the grinder in again, it should turn counter-clockwise.



NOTE: The coffee grinder should be used in areas with a room temperature below 30/35°C (86/95°F) and should not be installed in places (SUCH AS INDUSTRIAL KITCHENS) where cleaning with water jets is used.

8. OPERATION

8.1. Main switch

The main switch (12) has 2 positions of use, **ON-OFF**

ON: Working

OFF: Not working

8.2. Hopper placement

Remove the upper body (❸) by unscrewing the two screws on the backside of the grinder.

Place the hopper (❷) on the upper body and make sure that the hinge of the hopper lid (❶) lines up with the backside of the grinder. Push down and turn clockwise until the hopper clicks into place on the upper body (❸) (Fig. 4 & 5).



Fig. 3



Fig. 4



Fig. 5

Turn the upper body around and fix the hopper to the grinder body with the safety screw that comes along with the grinder (Fig. 3).



NOTE: The manufacturer cannot accept responsibility for any damage caused by improper use of the machine.

8.3. Use

Open the hopper lid (❶), fill the hopper (❷) with coffee and close the lid. **Once the coffee is inside the hopper, it can not be removed.**

Press the bag support handle (❺) and put the empty bag around the coffee discharge tube (❷), then release the handle so the bag remains fixed in place.

Push the start button (5) on the left of the front setting dial (4) and the grinding process will start (the selected grinding choice icon will flash). Once you have ground the desired quantity of coffee, push the grinding stop button (5) on the right of the front setting dial (4).

Remove the bag, holding it with one hand and with the other, push the bag support handle (6) down to release it.











Push the handle two or three more times against the outlet to remove so that any remaining traces of coffee which may have stuck to the discharge tube (7).



Fig. 6



NOTE: The amount of coffee ground will depend on the chosen grinding point.

1 coffee bean		
		100 - 300 particles <i>French Press</i>
		500 - 800 particles <i>Filter</i>
		1,000 - 3,000 particles <i>Mocha</i>
		3,500 particles <i>Espresso</i>
		15,000 - 35,000 particles <i>Turkish</i>

9. VIBRATING PLATE

9.1. Vibrating plate

The grinder comes with an extension to distance the bag shaker from the machine, allowing the possibility to use bigger bags (>0.55 lb for **R80** & **R100** and >1.1 lb for **R120** & **R140**) and therefore grinder larger amounts coffee.

To put the extension in place, remove the screw (9) on the lower part of the bag shaker as indicated in *Fig. 7* and put the adapter in place. Reconnect the bag shaker using the same screw.



Fig. 7

10. CLEANING

10.1. General warnings

To guarantee the correct operation of the machine as well as the quality of the ground coffee, periodically clean the parts that come into contact with the coffee (at least once a week).

Before performing any type of maintenance work, the following indications must be taken into consideration:

- Always turn off the machine using the general switch (12).
- Disconnect the machine from the power supply.
- Do not submerge the grinder in water or use power washing devices.
- The appliance is not to be cleaned with a water jet.

10.2. Bean hopper cleaning

It is recommended that the grind chamber be cleaned monthly with a cleaner as recommended by Compak. This process will eliminate smelly residues from the coffee remains, which can negatively affect the quality of the brewed coffee.

The steps to follow are:

- Grind out the remaining coffee in the grind chamber.
- Pour 60 gr of grinder cleaning product into the bean hopper (2).
- Grind the cleaning product at a medium course grind setting until it is passed through the system and nothing remains in the grind chamber.
- Clean the hopper (2) and refill with coffee beans.
- Discard the first 2-3 doses of coffee to assure that the residual cleaning product is removed from the grind chamber and set the grind regulator to the desired setting (4).

Following these steps will ensure that the grinder is clean and ready for use.

We do not recommend the taking apart of the grind assembly unless changing burrs, or removing a blockage/obstruction in the grind chamber. Removal of the grind assembly should be performed by a qualified service technician.

10.3. Cleaning the coffee discharge tube

To clean the tube (7) use the brush that comes with the grinder and insert it several times to remove any coffee remains.



Fig. 8



ALERT: It is recommended to follow the cleaning instruction described in this point at least once a month.

10.4. Cleaning the outside of the grinder

To clean the outside, use a dry brush and then a cloth that has been slightly dampened in soapy water.



NOTE: FAILURE to perform these cleaning operations will affect the taste and aroma of the coffee.

11. MAINTENANCE

11.1. General warning

Before performing any type of maintenance you should:

- Always turn **OFF** the main power switch to the off position (12).
- If the grinder is jammed, unplug it from the power source and contact an authorized service technician.



Not following these warnings can compromise the safety of the grinder as well as the user.

11.2. General maintenance of the grind chamber

To guarantee the efficiency and correct operation of the grinder, it is essential to follow manufacturer instructions and ensure that all maintenance work is carried out by qualified staff.

Dull burrs will result in; a lower quality grind, greater heat generation in the coffee and grinder, increased electrical consumption, and finally it puts additional stress on the grinder motor.



NOTE: Based on extensive experience and a medium-hard coffee blend, we recommend replacing the burrs according to the following table:

	Kg / lb of ground coffee
R8	800 Kg / 1322.77 lb
R80	6.800 Kg / 14,991.43 lb
R100	10.000 Kg / 22,046.23 lb
R120	12.000 Kg / 26,455.47 lb
R140	15.000 Kg / 33,069.34 lb

11.3. Grinding group maintenance



Not following the recommended burr life guidelines can compromise the safety of the grinder.

These operations should be done by a qualified service technician.

- To effect grinding group maintenance work, the following instructions should be followed:
- Turn the front setting dial (4) all the way to the left.
- Turn the machine off, using the **ON-OFF** switch (12).
- Disconnect the cable from the power supply.
- Remove hopper (2) from upper body (3) according to **section 7**.
- Dismantle upper body (3), by unscrewing the two rear screws. Remove the four setting screws (a) of the upper burr holder from the grinding cup (Allen wrench 4), according to **Fig. 8**.
- Replace the burrs by unscrewing them from their upper and lower supports. During this operation, it is recommended to block the rotation of the lower burrs with a at-head screwdriver.
- Clean the coffee remains from burr holders.
- Take out the used burrs and put in the new ones.
- Assemble to setting screws (a) of the upper burr holder to the grinding cup.

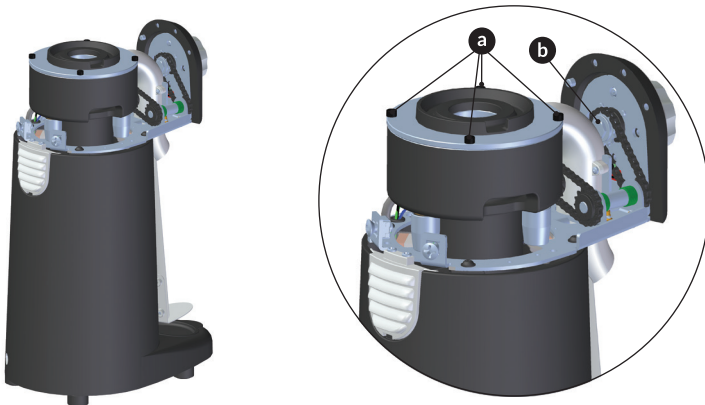

Fig. 9

11.4. Reset the burrs to the 0 / Calibration

Position 0 is the point in which the burrs no longer touch.

Following these instructions allows the user to make small adjustments to adapt the desired particle size for each of the types of coffee referenced on the front control knob (4).

- Turn the front dial (4) clockwise until the burrs are as close as possible without touching.
- Loosen, with the help of the key wrench that comes with the grinder, the screw (b), until the chain is released.
- Turn the front dial (4) clockwise as far as possible.
- Tighten the screw (b).
- Assemble the upper body (3), tightening the two rear screws and replace the hopper.

12. EC CONFORMITY

In accordance with European community directives, quality certificates have been applied. All materials have been adapted and technical reports are available at our offices.

04/108/EC on the approximation of the laws of the Member States relating to electromagnetic compatibility.

06/42/EC amending Directive 89/392/EC on the approximation of the laws of the Member States relating to machinery

REG. 1935/2004 amending Directive 89/109/CE on the approximation of the laws of the Member States relating to material and objects destined to make contact with nutritional products.

03/108/EC amending Directive 2002/96/EC on waste electrical and electronic equipment (WEEE).

06/95/EC of 12/12/2006 on the harmonization of the laws of Member States relating to electrical equipment designed for use within certain voltage limits.

02/96/EC of 27/01/2003 on the approximation of the laws of the Member States on waste electrical and electronic equipment (WEEE).

11/65/EU related to the restriction on the usage of certain dangerous substances with electrical equipment and electronics.



Environment

Do not throw the appliance away with the normal household waste; hand it in at an official recycling collection point. By doing this, you will help to preserve the environment.

The Legal Representative
Jesús Ascaso



Compak Coffee Grinders, s.a.

Molí Barri, Parcela B - Pol. Ind. Can Barri - 08415 Bigues i Riells - Barcelona - Spain
Ph. 34 93 703 13 00 - Fax 34 93 703 13 23 - www.compak.es

