

# Brewista®

## Stout Spout™ Variable Temperature Kettle

BSS12VTK Series

1.2L Variable Temperature Digital Kettle

Customer Service (North America): 1-888-538-8683

Local (Wyoming, USA): 307-222-6086

Email: [help@mybrewista.com](mailto:help@mybrewista.com)



**READ THIS MANUAL PRIOR TO FIRST USE  
AND SAVE FOR FUTURE REFERENCE**

Household Use Only

1-year Limited Warranty

\*Product appearance varies slightly between North American and all other markets.

# IMPORTANT SAFEGUARDS

---

When using electrical appliances, basic safety precautions should always be followed including the following:

- Read all instructions.
- Do not touch hot surfaces. Use handles or knobs.
- To protect against fire, electric shock and injury to persons, do not immerse cord, plugs, base or kettle in water or other liquid.
- Never leave the appliance unattended when in use. Close supervision is necessary when any appliance is used by or near children.
- Unplug from outlet when not in use, no water in kettle, filling water, moving kettle and before cleaning. Allow to cool before putting on or taking off parts, and before cleaning the appliance.
- Do not operate any appliance with a damaged cord or plug or after the appliance malfunctions, or has been damaged in any manner. Call our toll-free Customer Assistance Number for examination, repair or adjustment.
- Do not use a base unit other than the one supplied. The use of accessory attachments not recommended by the appliance manufacturer may result in fire, electric shock or injury to persons.
- Do not use outdoors.
- Do not let cord hang over edge of table or counter, or touch hot surfaces. Always store excess portion of the power cord in the compartment of the base unit.
- Electric kettle must be operated on a flat surface. Do not place on or near a hot gas or electric burner, or in a heated oven, or on the top of other electric appliances.
- Always attach plug to appliance first, then plug cord into the wall outlet. To disconnect, turn control to off, then remove plug from wall outlet.
- Do not use appliance for any purpose other than intended use.
- To avoid circuit overload, do not operate another high wattage appliance on the same circuit.
- Do not fill kettle when positioned on base. Remove all moisture on the bottom of the body before placing it onto the power base.
- Be aware of steam being emitted from spout or lid especially during refilling. Do not remove lid during boiling cycle.
- Do not use the kettle to heat anything other than water. Do not fill above the "max" indication. Do not operate kettle if water is below minimum marking. If the kettle is overfilled, boiling water may be ejected. The kettle is only to use with the base unit provided.
- Do not insert any object into slots or holes of the kettle.
- Scalding may occur if the lid is removed during the boiling cycles.

## SAVE THESE INSTRUCTIONS

- If the supplied cord is damaged, it must be replaced by the manufacturer, its service agent, or a similarly qualified person in order to avoid hazard.
- The appliance can be used by children ages 8 years and older and persons with reduced physical, sensory, or mental capabilities or lack the experience and knowledge if they have been given supervision or instruction concerning the use of the appliance in a safe way and understand the hazards involved. Cleaning and user maintenance shall not be made by children unless they are older than 8 and supervised.
- Keep the appliance and its cord out of reach of children less than 8 years old.
- WARNING: Do not remove the lid while water is boiling
- WARNING: Position the lid so that steam is directed away from the handle.

## **SAVE THESE INSTRUCTIONS**

# ADDITIONAL SAFEGUARDS

DO NOT OPERATE APPLIANCE IF THE LINE CORD SHOWS ANY DAMAGE OR IF APPLIANCE WORKS INTERMITTENTLY OR STOPS WORKING ENTIRELY.

## EXTENSION CORDS

A short power-supply cord is to be provided to reduce the risk resulting from becoming entangled in or tripping over a longer cord. Longer detachable power-supply cords or extension cords are available and may be used if care is exercised in their use. If a longer detachable power-supply cord or extension cord is used,

- 1) The marked electrical rating of the cord set or extension cord should be at least as great as the electrical rating of the appliance, and
- 2) The extension cord should be a grounding-type 3-wire cord, and
- 3) The longer cord should be arranged so that it will not drape over the countertop or tabletop where it can be tripped over, snagged, or pulled on unintentionally (especially by children).

## GROUNDING INSTRUCTIONS

This appliance must be grounded while in use.

CAUTION: To ensure continued protection against risk of electric shock, connect to properly grounded outlets only.

## GROUNDING INSTRUCTIONS

In North American markets the appliance has a plug that looks like Figure A. Kettles sold outside of North America include removable power cords for use with electrical outlets in those markets. **DO NOT attempt to insert a power cord into an incompatible outlet.** Appliance damage, electrical system damage or physical harm may result. An adaptor, as shown in Figure B, should be used for connecting a 3-prong grounding plug to a 2-wire receptacle. The grounding tab, which extends from the adaptor, must be connected to a permanent ground such as a properly grounded receptacle as shown in Figure C, using a metal screw.

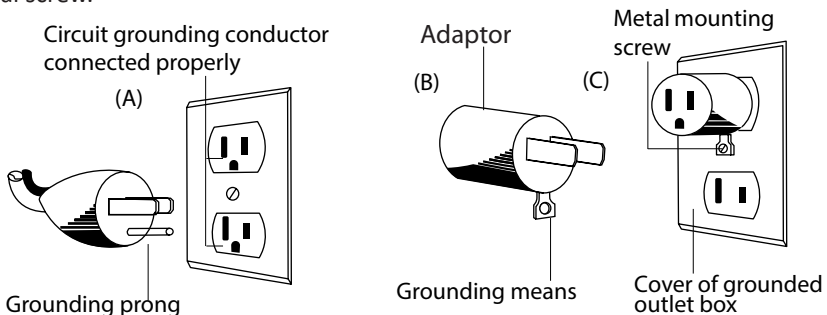

Warning: This appliance utilizes a high wattage relay for arriving at the desired water temperature. In some instances, this relay may cause slight flickering of lights on the same circuit. It is best to use this appliance on a dedicated circuit or with all other appliances off during this appliance's use. It will not damage electrical systems but caution should be used to not overload this circuit with other appliances running at the same time.

## Table of Contents

---

Cover/Customer Service Information	1
IMPORTANT SAFEGUARDS	2
ADDITIONAL SAFEGUARDS	4
Variable Temperature Kettle Components	6
Operation Illustrations	7
Operation Instructions	7
• Setting Up the Kettle	7
• Preparing the Kettle for First Time Use	8
• Setting the Current Time	8
• Selecting the Temperature Display, Fahrenheit or Celsius	8
• Setting the Temperature	8
◦ Suggested Temperature Chart	8
◦ Manual Boiling	9
◦ Selecting a Preset Temperature	9
◦ Manually Setting the Desired Temperature	9
• Programing for Automatic Use (Auto-start Function)	10
◦ Setting the Keep Warm Function	11
◦ Count-up Timer Feature	11
◦ Adjusting Kettle Lid Tension	11
◦ Maintenance and Cleaning	12
◦ Storage	12
◦ Decalcifying	12
• Brewista recommends Cafetto™ Descaler	12
• High Altitude Users	13
• Warnings and Technical Data	13
• Preparing Coffee	14
1-year Limited Warranty Information	15
Correct Disposal of this Product	15

## Variable Temperature Kettle Components

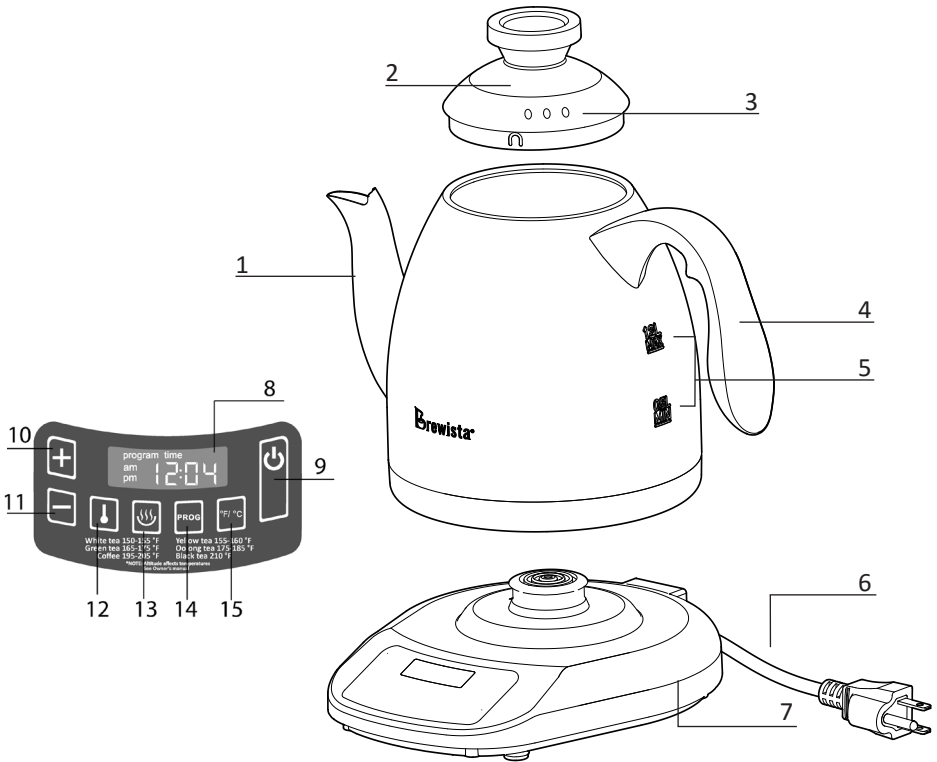

- |  |                                   |
|--|-----------------------------------|
| 1) Spout   | 7) Base                           |
| 2) Lid   | 8) LCD Readout                    |
| 3) Vent Holes  | 9) ON/OFF button                  |
| 4) Handle  | 10) [+ ] button                   |
| 5) Max & Min water level indicators  | 11) [- ] button                   |
| 6) Power cord with plug  | 12) TEMPERATURE SETTING button    |
| <ul style="list-style-type: none"> <li>• <i>Kettles sold outside of North America include removable power cords to accommodate electrical outlets in those markets.</i></li> </ul> | 13) KEEP WARM button              |
|  | 14) PROG / Program setting button |
|  | 15) Display degree °F / °C button |

## Operation Illustrations

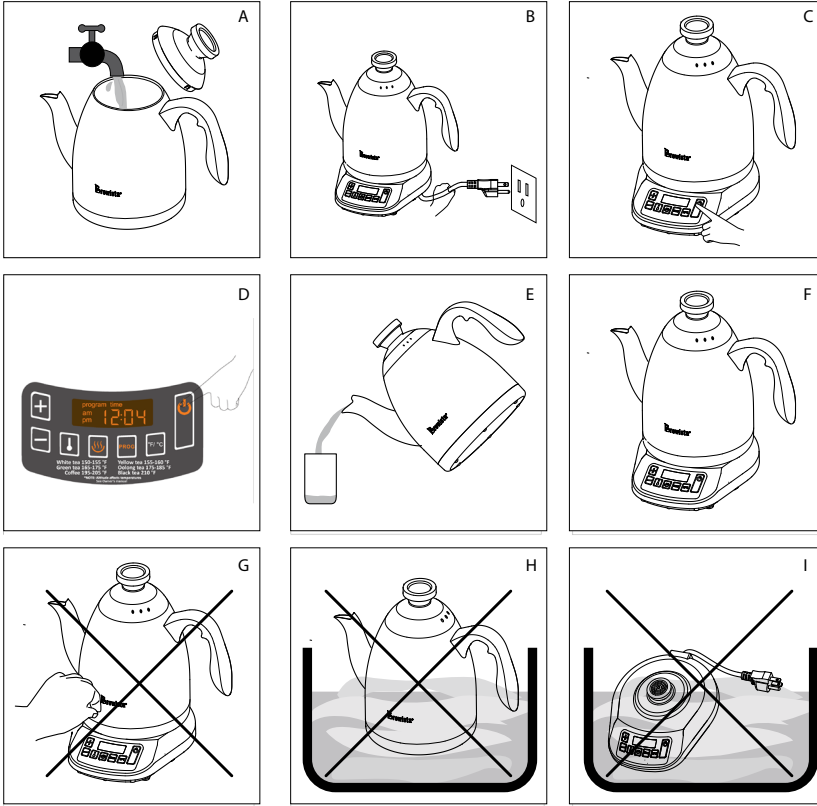

## OPERATION INSTRUCTIONS

**Note:** Before plugging the kettle into the wall outlet, check that the electrical circuit is not overloaded with other appliances.

### 1 Setting Up the Kettle:

- Set the base (7) on a flat, steady surface.
- Remove the kettle from the base (7).
- Take off the lid (2).
- Fill the kettle with cold water (illustration A).

**IMPORTANT!** Do not fill above the “max” fill line (1.2L) marked inside of the kettle.

- After filling the kettle with water, replace the lid (2) securely with the vent holes (3) facing away from the handle and place the kettle firmly on the base.
- Plug the power cord into a grounded wall outlet (illustration B), the display will flash “am time 12:00”. If your kettle includes a removable power cord, insert the female end of that cord into the base first.

## 2 Preparing the Kettle for First Time Use:

- Fill the kettle to the “Max” fill line with cold water.
- Replace the lid (2) with holes (3) facing away from the handle.
- Press ON/OFF button (9) to begin heating cycle.
- Bring water to a boil, then empty the kettle.
- Allow the appliance to cool down for 1 minute.
- Repeat boil and rinse procedure twice before using.

## 3 Setting the Current Time:

- Plug the power cord into the wall outlet and the display will flash “am time 12:00”.
- Press the [ + ] button (10) to change the hour.
  - Press the button once to increase by one hour.
  - Holding the [ + ] button down for more than 1.5 seconds will cause the number to flash, then increase faster. When the LCD hour display is close to the desired time, release the button.
  - Press the [ + ] button once to increase the hour by one until the desired hour is reached.
- Press the [ - ] button (11) to change the minutes.
  - Press the button once to increase by one minute.
  - Holding the [ - ] button down for more than 1.5 seconds will cause the number to flash, then increase faster. When the LCD minute display is close to the desired time, release the button.
  - Press the [ - ] button once to increase the minutes by one until the desired minutes are reached.
- After 3 seconds of inactivity the set time will be stored.
- To change the time once it has been set, press and hold the [ + ] button (10) for 3 seconds. The LCD will flash the current time.
  - Adjust the time following the above instructions.

## 4 Selecting the Temperature Display, Fahrenheit or Celsius:

- When the base is powered on, press the °F / °C button (15) to change the temperature display to either Fahrenheit or Celsius.

## 5 Setting the Temperature:

**Note:** At higher altitudes water boils at lower temperatures. Do not set the temperature above the water boiling point. Refer to the graph in the “High Altitude Users” section later in this manual to determine the boiling temperature for your altitude.

### Suggested Temperature Chart:

Beverage	Suggested Temp.	Beverage	Suggested Temp.
<b>White Tea</b>	150 - 155 °F (65 - 68 °C)	<b>Cocoa</b>	175 - 185 °F (79 - 85 °C)
<b>Yellow Tea</b>	155 - 160 °F (68 - 71 °C)	<b>Hot Cereal</b>	195 - 205 °F (90 - 96 °C)
<b>Green Tea</b>	165 - 175 °F (74 - 79 °C)	<b>Coffee</b>	195 - 205 °F (90 - 96 °C)
<b>Oolong Tea</b>	175 - 185 °F (79 - 85 °C)	<b>Black Tea</b>	205 - 210 °F (96 - 99 °C)



- **Manual Boiling (illustration D):**
  - Press the ON/OFF button (9) to start boiling automatically at the factory default temperature of 96 °C (205 °F).
    - If a different temperature has already been set, the factory default is no longer active and the last temperature setting will be recalled.
  - The LCD display will flash the programmed temperature three times and then display the current temperature inside the kettle.
  - When the set temperature is reached, three audible beeps are emitted.
- **Selecting a Preset Temperature:**
  - Repeatedly press the TEMPERATURE SETTING button (12) until the desired preset temperature is displayed.
    - The factory preset temperatures are: 60 °C (140 °F), 80 °C (176 °F), 85 °C (185 °F), 88 °C (190 °F), 96 °C (205 °F) and 98 °C (208 °F).
    - The factory default temperature is 96 °C (205 °F)
  - Press ON/OFF button (9) to begin the heating cycle.
  - When the set temperature is reached, three audible beeps are emitted.
- **Manually Setting the Desired Temperature:**
  - Press the TEMPERATURE SETTING button (12); the last set temperature will flash on the display.
  - Press the [ + ] button (10) or [ - ] button (11) to select the desired temperature.
  - Once the display stops flashing, the temperature is set and the LCD displays the current water temperature.
  - Press ON/OFF button (9) to begin the heating cycle.
  - When the set temperature is reached, three audible beeps are emitted.

**Notes:**

- To manually interrupt the heating process, press the ON/OFF button (9) or remove the kettle from the base at any time.
- Once the temperature has been set, it is stored in memory and will be recalled the next time the kettle is turned on. The factory default temperature of 96 °C (205 °F) will no longer be active after a different temperature is set.
- During the heating cycle, the LCD will display the current water temperature.
- The LCD will continue to show the water temperature for one hour if the kettle is not removed from the base.
- If the kettle is removed from the base during the heating cycle, the heating cycle will turn off, the ON/OFF button (9) indicator light will turn off, and the LCD will display “0 00”.
- When the kettle is returned to the base, the display will show the current water temperature for 1 hour.
- To resume the heating cycle and/or keep warm function, the user must press the corresponding buttons once the kettle is returned to the base.
- After one hour, the LCD back light will dim and the screen will display the current time.

## 6 Program for Automatic Use (Auto-start Function)

- **Note:** The Auto-start time is the time at which the automatic heating cycle will be complete.
- Prior to programming your kettle, be sure to set the correct current time if it is not already set.
- Press the PROG button (14) once. The current time will flash for 5 seconds.
  - While the current time is flashing;
    - Press the [ + ] and [ - ] buttons to change the current time, or wait five (5) seconds to automatically save the time displayed as the current time.
  - Once the current time is stored, the Auto-start time will flash for 5 seconds.
  - While the Auto-start time is flashing;
    - Press the [ + ] and [ - ] buttons to change the Auto-start time, or wait five (5) seconds to automatically save the time displayed as the time when the Auto-start program will be completed.
  - Once the Auto-start time is stored, the LCD will flash the programmed temperature setting in the LCD.
    - Press the [ + ] and [ - ] buttons to set desired temperature, or wait five (5) seconds to automatically save the temperature displayed as the programmed temperature.
- Press the KEEP WARM button (13) to maintain the set temperature after the Auto-start heating cycle (optional).
  - If the keep warm function is not active, the kettle will reach the set temperature and shut off heater.

### Notes:

- Once set, the Auto-start function is active. The program LED is illuminated and the LCD displays “program”.
- Press the KEEP WARM button (13) once to activate the keep warm function (optional).
- Press the PROG button (14) again before the program starts to cancel the Auto-start function.
- If the kettle is removed from the base while in program mode, the PROG button (14) and the KEEP WARM button (13) must be pressed again once the kettle is returned to the base to resume these functions.
- When the Auto-start program function is active:
  - Press the [ + ] button once and the LCD will display the current time for a few seconds.
  - Press the [ - ] button once and the LCD will display the Auto-start completion time for a few seconds.
- When the programmed Auto-start time is reached, the heating process will be complete.
- When the set temperature is reached, three audible beeps are emitted.

- If the Auto-start program time and current time are less than eight (8) minutes apart, the kettle will begin heating immediately.
- To manually interrupt the heating process, press the ON/OFF button (9) or remove the kettle from the base at any time.

### 7 Setting the Keep Warm Function (optional):

- Press the KEEP WARM button (13) at any time to activate or deactivate the function.
- When the keep warm function is active, the KEEP WARM LED is illuminated.
- After the heating cycle is complete, the set temperature will be maintained for one hour.
- If the kettle is removed from the base, the kettle must be returned to the base and the KEEP WARM button (13) must be pressed again to reactivate the function.

### 8 Count-up Timer Feature:

- When the kettle is removed from the base, the LCD will display 0:00.
  - Press the [ + ] button (10) to start the count-up timer.
  - The first digit indicates the minutes, and the last two digits indicate the seconds (see illustration above).
  - The maximum count-up time is 7 minutes.
- Set the kettle back on the base to cancel the timer.



### 9 Adjusting Kettle Lid Tension

If you feel the kettle lid is too hard or too easy to remove from the kettle, please follow the steps below to adjust the tension:

- 1) Take the lid off the kettle.
- 2) Use a pair of needle-nosed pliers or similar tool to adjust the three tabs of the kettle lid. If you push in the tab, the lid tension will be reduced and easier to put on and take off. If you pull out the tabs the lid will be harder to pull off.
- 3) After adjusting the tabs, replace the lid and remove it again to see if the adjustment is correct.
- 4) Repeat steps 2 and 3 until you have adjusted the lid to your preference.

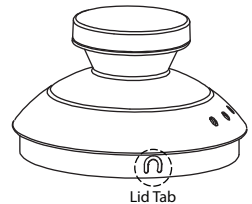

## 10 Maintenance and Cleaning:

- This appliance contains no user serviceable parts and requires little maintenance.
  - Refer any servicing or repairs to qualified personnel.
- Clean the kettle regularly.
  - Clean the outside of the base and the kettle with a damp, soft cloth.
- Clean the inside of kettle with dish detergent and rinse thoroughly with water.
  - Do not use abrasive cleaners.
  - After cleaning, dry the kettle and the base thoroughly.

**WARNING: Never immerse the kettle or the base in water or other liquids.**  
**WARNING: Always unplug kettle and wait for kettle to cool prior to cleaning.**

## 11 Storage:

- Clean and dry all parts before storing.
- Store the kettle in its box or in a clean, dry place.
- Never wrap the power cord around the kettle.
  - Bases with attached power cords have cord storage on the bottom. Wrap the attached cord around this feature.
  - Removable power cords should be disconnected from the base and stored properly.

## 11 Decalcifying:

- When mineral scale builds up in the kettle, it can affect temperature consistency and slow down heating time.
- To ensure optimum performance, Brewista recommends descaling the kettle when mineral build-up is visible inside the kettle.

**Note:** Vinegar may not effectively descale the kettle and can be difficult to thoroughly rinse. Vinegar may also leave behind an odor that could affect future use.

***Brewista recommends using Cafetto™ Descaler.***



### How to use Cafetto™ Descaler:

- 1) Mix 1 packet Cafetto™ Descaler with 40 oz. of lukewarm water.
- 2) Pour the solution into the kettle.
- 3) Bring the solution to a boil.
- 4) Let the vessel cool for 15 minutes, then discard the solution.
- 5) Rinse thoroughly with fresh water.

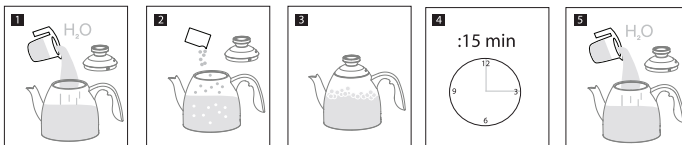

## High Altitude Users

At higher elevations water boils at lower temperatures. Use the graph below to determine your kettle's boiling temperature.

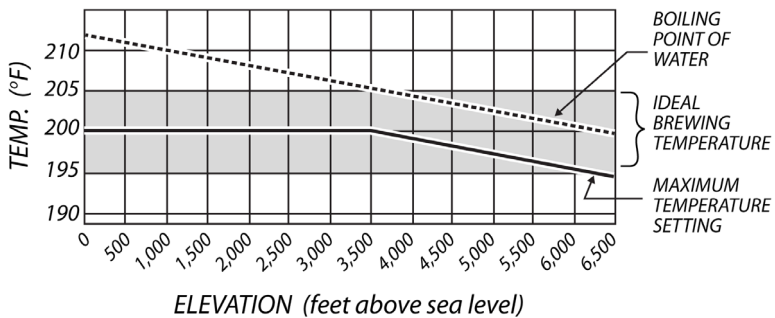
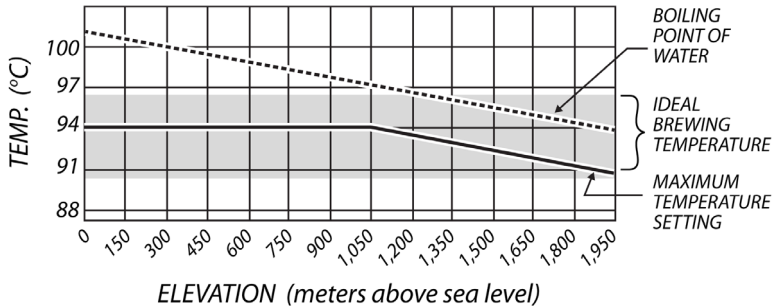

**WARNING:** The appliance is very hot during use. Do not touch the surface of the kettle. Danger of burns!

**WARNING:** Never leave the kettle unattended while boiling water, especially if there are children nearby.

**WARNING:** Do not open the lid while boiling water.

**WARNING:** Do not immerse the base or the kettle in water or any other liquid. This may cause electric shock or damage the appliance.

**WARNING:** Be careful when handling hot water. Danger of scalding!

## TECHNICAL DATA

For countries with voltage ranging from 110-127V

Rated voltage: 120 V ~60 Hz

Rated current: 10A

Rated power input: 1200W

Capacity: Max. 40.5 Oz (1.2L)

For countries with voltage ranging from 220-240V

Rated voltage: 220-240 V ~50/60 Hz

Rated power input: 1500W

Capacity: Max. 40.5 Oz (1.2L)

## Preparing Coffee

### Pour Over Manual Brew Coffee

This is the simplest coffee brewing approach. It allows the individual the most control of saturation of the coffee grounds, also the most participation by the user. It requires more time than hitting the ON switch of a drip coffee maker but for many, its higher involvement is part of the pleasure of coffee overall.

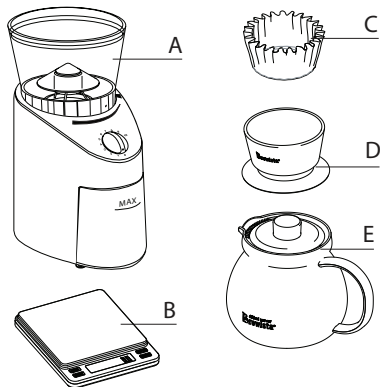

- A. Grinder
- B. Scale (Brewista Smart Scale™ recommended)
- C. Paper filter, cloth or permanent filter
- D. Pour over filter basket (Brewista Smart Dripper™ recommended)
- E. Drinking cup or carafe
- F. Method for boiling water (Brewista kettle recommended)

### Brewing Manual Pour Over Method

- Measure about 6 ounces of water for each cup you intend to brew. Place measured water in kettle and turn on kettle to bring water to desired temperature.
- Grind two tablespoons of beans per cup of coffee.
- Rinse the filter, dripper, and glass server (or whatever you are brewing into) in hot water to preheat them.
- Assemble the filter, dripper and vessel and dump the ground coffee into the filter.
- When the water reaches the programmed temperature, remove the kettle from the base. The desired coffee brewing temperature is 205° F, slightly lower than boiling temperature.
- Now pour the water into the filter. Stir the coffee just a bit to be sure it all gets saturated with water. A slow, steady pour allows for the best extraction from the grounds.

#### Tips:

- You may have to pour two or three times depending in the grind, filter size, and amount of coffee being made.
- Pre-wetting the coffee grounds a minute before start pour over helps extraction.
- A narrower spout allows better water flow control.
- Pour over coffee is usually ground finer than drip coffee maker, but not as fine as espresso.

## LIMITED WARRANTY

---

### 1-Year Limited Warranty from the date of original purchase.

1. This warranty extends only to the original consumer, purchaser, or gift recipient. Keep the original sales receipt, as proof of purchase is required to make a warranty claim. The product must be purchased at an authorized retailer for the warranty to be valid.
2. Defects that occur due to improper connection, improper handling, poor water quality, or repair attempts by non-authorized persons are not covered by the warranty. The same applies for failure to comply with the use of consumables (e.g. cleaning and decalcifying agents) that do not correspond to the original specifications.
3. Routine wear parts (e.g. seals and valves, permanent filter) and fragile parts, like glass, are excluded from the warranty.
4. Damages which are not under responsibility of the manufacturer are not covered by the warranty. This is valid, especially for claims arising from improper use (e.g. operation with wrong type of current or voltage).
5. The guarantee becomes void if repairs are carried out by third parties, who are not authorized by the manufacturer to do so and/or if spare parts are used other those from the original equipment manufacturer.
6. Failure to comply with any important safeguards listed in section 1 will void the limited warranty.
7. Household-use only.

To make a warranty claim, do not return this appliance to the store. Please email [help@mybrewista.com](mailto:help@mybrewista.com) or call 1-888-538-8683. For faster service, locate the model, type, and serial numbers on your appliance and have available for the call or include in your email.



### Correct Disposal of this Product

This symbol indicates that this product should not be disposed of with other household wastes throughout the European Union. To prevent possible harm to the environment or human health from uncontrolled waste disposal, recycle it responsibly to promote the sustainable reuse of material resources. To return your used device, please use the return and collection systems or contact the retailer where the product was purchased. They can collect this product for environmentally safe recycling.



# Brewista®

## Stout Spout™ Variable Temperature Kettle

BSS12VTK Series

1133 W. 27th Street, Cheyenne, WY 82001, USA | [www.mybrewista.com](http://www.mybrewista.com)

Toll Free in North America: 888-538-8683 | Local: 307-222-6086